

## Lecture (03) Circuit switching

Dr. Ahmed ElShafee

## Agenda

- Switched communication network
- Circuit switching technology

## switched communication network

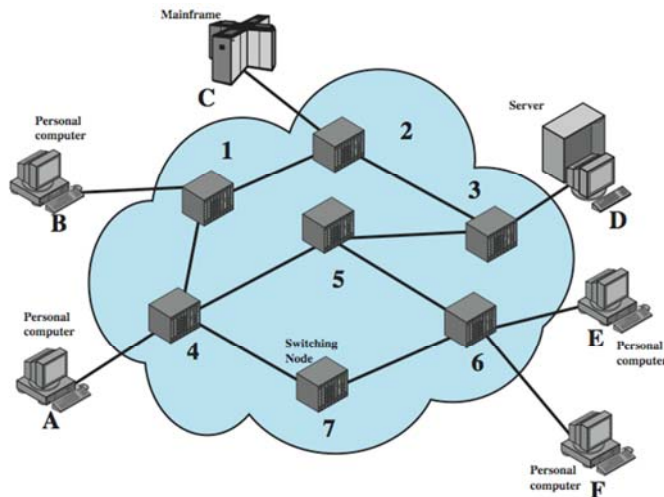

## switched communication network (cont,..)

### Terminologies:

- For transmission of data beyond a local area, communication is achieved by transmitting data from source to destination through a network of intermediate switching nodes;
- The switching nodes are not concerned with the content of the data their purpose is to provide a switching facility that will move the data from node to node until they reach their destination.
- **Stations:** The devices attached to the network, computers, terminals, telephones, or other communicating devices
- **Node:** switching devices whose purpose is to provide communication
- **transmission links:** connection between nodes and terminals

## switched communication network (cont,..)

- Node-node links are usually multiplexed, using either frequency division multiplexing (FDM) or time division multiplexing (TDM).

TDM

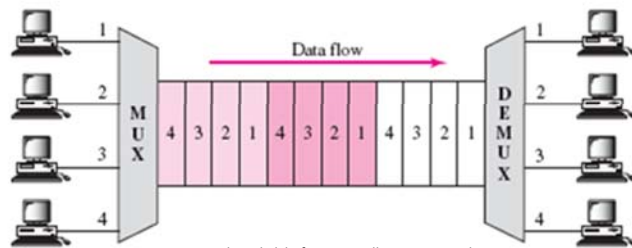

Dr. Ahmed ElShafee, ACU Fall 2011, Networks I

## switched communication network (cont,..)

Frequency-division multiplexing

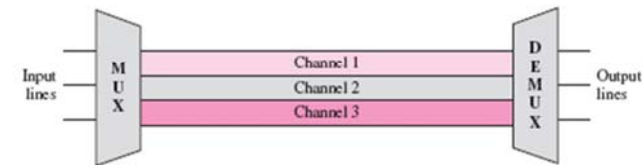

Dr. Ahmed ElShafee, ACU Fall 2011, Networks I

## switched communication network (cont,..)

### How it works?

- data entering the network from a station are routed to the destination by being switched from node to node.
- data from station A intended for station F are sent to node 4.
- They may then be routed via nodes 5 and 6 or nodes 7 and 6 to the destination.

Dr. Ahmed ElShafee, ACU Fall 2011, Networks I

## switched communication network (cont,..)

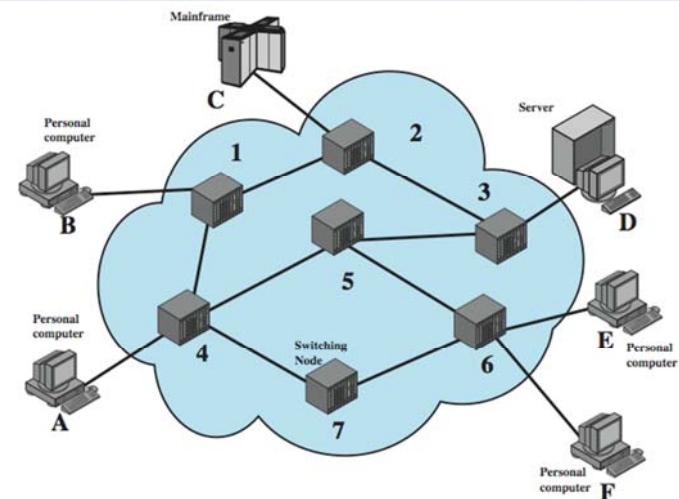

Dr. Ahmed ElShafee, ACU Fall 2011, Networks I

## switched communication network (cont,..)

---

### Topology:

- Each station attaches to a node
- Some nodes connect only to other nodes (eg., 5 and 7 on previous slide). (sole task is the internal (to the network) switching of data.)
- Other nodes have one or more stations attached as well (such nodes accept data from and deliver data to the attached stations.)
- It's recommended that each connection has more than one possible path through the network for each pair of stations.
- This enhances the reliability of the network.

9

Dr. Ahmed ElShafee, ACU Fall 2011, Networks I

## switched communication network (cont,..)

---

### Switching technologies

- Two different technologies are used in wide area switched networks: circuit switching and packet switching.
- These two technologies differ in the way the nodes switch information from one link to another on the way from source to destination.

10

Dr. Ahmed ElShafee, ACU Fall 2011, Networks I

## Circuit switching technology

---

- there is a dedicated communication path between two stations.
- That path is a connected sequence of links between network nodes.
- On each physical link, a logical channel is dedicated to the connection.
- Communication via circuit switching involves three phases:
  - **Circuit establishment**
  - **Data transfer**
  - **Circuit disconnect**

11

Dr. Ahmed ElShafee, ACU Fall 2011, Networks I

## Circuit switching technology (cont,..)

---

### Circuit establishment –

- Before any signals can be transmitted, an end-to-end (station-to-station) circuit must be established.

### Data transfer –

- Data can now be transmitted through the network between these two stations.
- The transmission may be analog or digital, depending on the nature of the network.
- As the carriers evolve to fully integrated digital networks, the use of digital (binary) transmission for both voice and data is becoming the dominant method.
- Generally, the connection is full duplex.

12

Dr. Ahmed ElShafee, ACU Fall 2011, Networks I

## Circuit switching technology (cont,..)

### Circuit disconnect –

- After some period of data transfer, the connection is terminated, usually by the action of one of the two stations.
- Signals must be propagated to the intermediate nodes to deallocate the dedicated resources.

١٣

Dr. Ahmed ElShafee, ACU Fall 2011, Networks I

## Circuit switching technology (cont,..)

### Disadvantages

- Circuit switching inefficient.
- Channel capacity is dedicated for the duration of a connection, even if no data are being transferred
- For a voice connection, utilization may be rather high, but it still does not approach 100%.
- For a client/server or terminal-to-computer connection, the capacity may be idle during most of the time of the connection.
- there is a delay prior to signal transfer for call establishment.

١٤

Dr. Ahmed ElShafee, ACU Fall 2011, Networks I

## Circuit switching technology (cont,..)

### Advantages

However, once the circuit is established, the network is effectively transparent to the users.

١٥

Dr. Ahmed ElShafee, ACU Fall 2011, Networks I

## Circuit switching technology (cont,..)

### Public Switched Telephone network

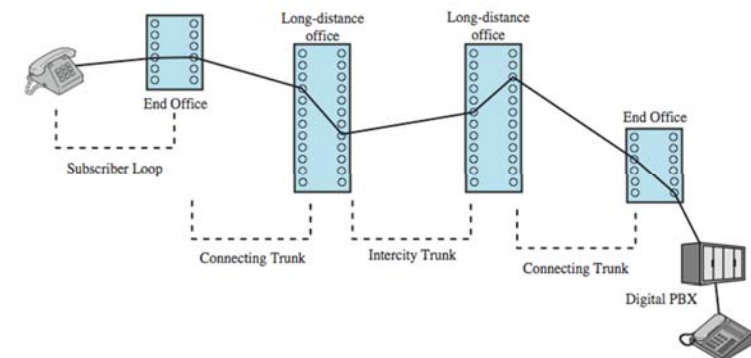

١٦

Dr. Ahmed ElShafee, ACU Fall 2011, Networks I

## Circuit switching technology (cont,..)

- Circuit switching was developed to handle voice traffic but is now also used for data traffic.
- The best-known example of a circuit-switching network is the public telephone network
- collection of national networks interconnected to form the international service.
- A public telecommunications network can be described using four generic architectural components:

17

Dr. Ahmed ElShafee, ACU Fall 2011, Networks I

## Circuit switching technology (cont,..)

- **Subscribers:** The devices that attach to the network, typically telephones, percentage of data traffic increases year by year.
- **Subscriber line:** The link between the subscriber and the network, also referred to as the **subscriber loop or local loop**, mostly using twisted-pair wire.
- **Exchanges:** The switching centers in the network. A switching center that directly supports subscribers is known as an end office.
- **Trunks:** The branches between exchanges. Trunks carry multiple voice frequency circuits using either FDM or synchronous TDM

18

Dr. Ahmed ElShafee, ACU Fall 2011, Networks I

## Circuit switching technology (cont,..)

### Circuit Establishment

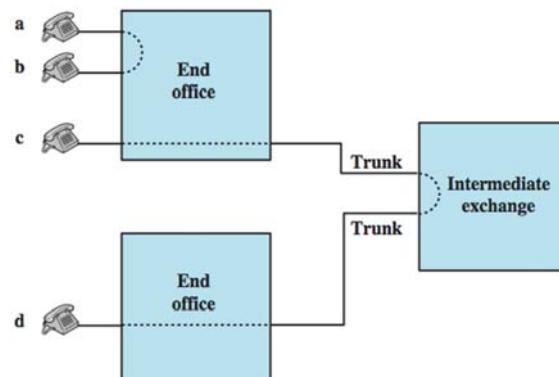

19

Dr. Ahmed ElShafee, ACU Fall 2011, Networks I

## Circuit switching technology (cont,..)

- Subscribers connect directly to an end office, which switches traffic between subscribers and between a subscriber and other exchanges.
- The other exchanges are responsible for routing and switching traffic between end offices.
- To connect two subscribers attached to the same end office, a circuit is set up between them.
- If two subscribers connect to different end offices, a circuit between them consists of a chain of circuits through one or more intermediate offices.

20

Dr. Ahmed ElShafee, ACU Fall 2011, Networks I

## Circuit switching technology (cont,..)

- “a” connection is established between lines “a” and “b” by simply setting up the connection through the end office.
- The connection between “c” and “d” is more complex.
- In “c”’s end office, a connection is established between line “c” and one channel on a TDM trunk to the intermediate switch.
- In the intermediate switch, that channel is connected to a channel on a TDM trunk to “d”’s end office. In that end office, the channel is connected to line d.

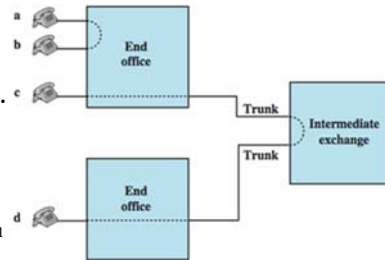

٢١

Dr. Ahmed ElShafee, ACU Fall 201

## Circuit switching technology (cont,..)

### key requirements for voice traffic

- there must be virtually no transmission delay
- certainly no variation in delay.
- A constant signal transmission rate must be maintained
- The quality of the received signal must be sufficiently high to provide, at a minimum, intelligibility.

These requirements are necessary to allow normal human conversation.

٢٢

Dr. Ahmed ElShafee, ACU Fall 2011, Networks I

## Circuit switching technology (cont,..)

### Conclusion

- Circuit switching , well suited to the analog transmission of voice signals
- In today’s digital world, Circuit switching is inefficient , although
- Circuit switching will remain an attractive choice for both local area and wide area networking.

٢٣

Dr. Ahmed ElShafee, ACU Fall 2011, Networks I

## Circuit switching technology (cont,..)

### Circuit Switch Elements (digital switch)

- A network built around a single circuit-switching node consists of a collection of stations attached to a central switching unit.
- The central switch establishes a dedicated path between any two devices that wish to communicate.

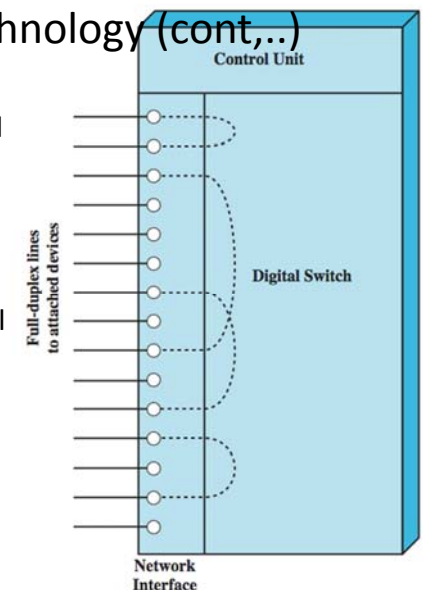

٢٤

## Circuit switching technology (cont,..)

- The dotted lines inside the switch symbolize the connections that are currently active.
- The heart of a modern system is a **digital switch**.

### digital switch

- The function is to provide a transparent signal path between any pair of attached devices.
- The path is transparent to the attached pair of devices that there is a direct connection between them.
- connection must allow full-duplex transmission.

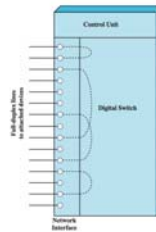

٢٥

Dr. Ahmed ElShafee, ACU Fall 2011, Networks I

## Circuit switching technology (cont,..)

### Components

- network interface
- Control unit

### 1. network interface

- element represents the functions and hardware needed to connect digital devices, such as data processing devices and digital telephones, to the network.
- Analog telephones can also be attached if the network interface contains the logic for converting to digital signals.
- Trunks to other digital switches carry TDM signals and provide the links for constructing multiple-node networks.

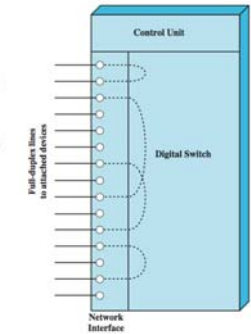

٢٦

Dr. Ahmed ElShafee, ACU Fall 2011, Networks I

## Circuit switching technology (cont,..)

### 2. control unit

performs three general tasks:

1. Establishes connections; as requested by the attached device.
2. Maintains the connection; because the digital switch uses time division principles, this may require ongoing manipulation of the switching elements.
3. Tear down the connection; either in response to a request from one of the parties or for its own reasons.

٢٧

Dr. Ahmed ElShafee, ACU Fall 2011, Networks I

## Circuit switching technology (cont,..)

### Blocking and non-blocking characteristic :

- Blocking occurs when the network is unable to connect two stations because all possible paths between them are already in use.
- nonblocking network permits all stations to be connected (in pairs) at once and grants all possible connection requests as long as the called party is free.

### Voice network point of view:

- When a network is supporting only voice traffic, a blocking configuration is generally acceptable, because it is expected that most phone calls are of short duration and that therefore only a fraction of the telephones will be engaged at any time.

٢٨

Dr. Ahmed ElShafee, ACU Fall 2011, Networks I

## Circuit switching technology (cont,..)

---

### Data network point of view:

- Not accepted, as data entry application, a terminal may be continuously connected to a computer for hours at a time.
- Specially if some sensitive operation is performed like money transfer (ATM machine and bank server)
- for data applications, there is a requirement for a no blocking or "nearly no blocking" (very low probability of blocking) configuration.

٢٩

Dr. Ahmed ElShafee, ACU Fall 2011, Networks I

## Circuit switching technology (cont,..)

---

### Space Division Switch

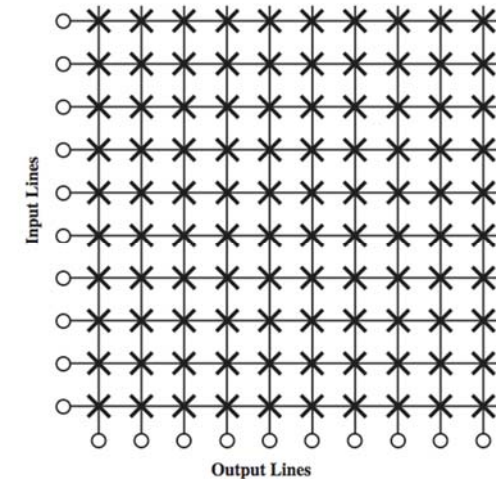

٣٠

## Circuit switching technology (cont,..)

---

- Space division switching was originally developed for the analog environment and has been carried over into the digital realm.
- Each connection requires the establishment of a physical path through the switch that is dedicated solely to the transfer of signals between the two endpoints.
- The basic building block of the switch is a metallic crosspoint or semiconductor gate that can be enabled and disabled by a control unit.
- Figure shows simple crossbar matrix with 10 full duplex I/O lines.

٣١

Dr. Ahmed ElShafee, ACU Fall 2011, Networks I

## Circuit switching technology (cont,..)

---

- The matrix has 10 inputs and 10 outputs; each station attaches to the matrix via one input and one output line.
- Interconnection is possible between any two lines by enabling the appropriate cross point.
- Note that a total of 100 cross points is required.

٣٢

Dr. Ahmed ElShafee, ACU Fall 2011, Networks I



## Circuit switching technology (cont,..)

### Advantages

- Non blocking system
- Simple control scheme

٣٣

Dr. Ahmed ElShafee, ACU Fall 2011, Networks I

## Circuit switching technology (cont,..)

### Disadvantages

- The number of cross points grows with the square of the number of attached stations.
- This is costly for a large switch.
- The loss of a cross point prevents connection between the two devices whose lines intersect at that cross point.
- The cross points are inefficiently utilized; even when all of the attached devices are active, only a small fraction of the cross points are engaged.

٣٤

Dr. Ahmed ElShafee, ACU Fall 2011, Networks I

## Circuit switching technology (cont,..)

### multiple-stage switches

- To overcome these limitations, multiple-stage switches are employed.

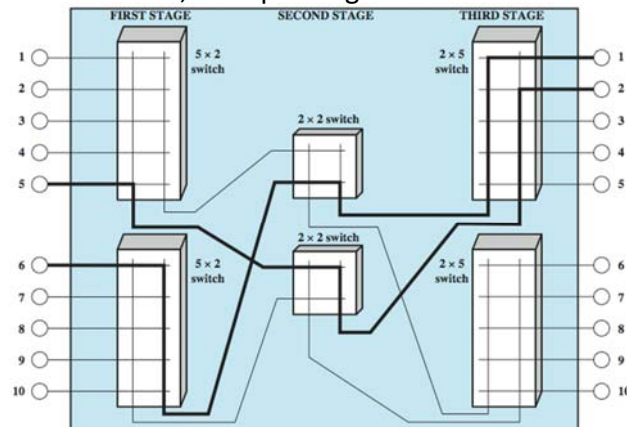

٣٥

Dr. Ahmed ElShafee, ACU Fall 2011, Networks I

## Circuit switching technology (cont,..)

### Advantages

1. The number of cross points is reduced,
  2. increasing crossbar utilization.
  3. Multiple paths/connections
- In the example, the total number of cross points for 10 stations is reduced from 100 to 48.
  - There is more than one path through the network to connect two endpoints, increasing reliability.

٣٦

Dr. Ahmed ElShafee, ACU Fall 2011, Networks I

## Circuit switching technology (cont,..)

### Disadvantages:

- System have some blocking probability.
- requires a more complex control scheme (free path through the stages must be determined and the appropriate gates enabled).

٣٧

Dr. Ahmed ElShafee, ACU Fall 2011, Networks I

## Circuit switching technology (cont,..)

- The heavier lines indicate the lines that are already in use.
- In this state, input line 10, for example, cannot be connected to output line 3, 4, or 5, even though all of these output lines are available.
- A multiple-stage switch can be made non-blocking by increasing the number or size of the intermediate switches, but of course this increases the cost.

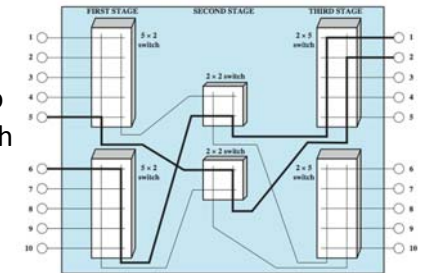

٣٨

Dr. Ahmed ElShafee, ACU Fall 2011, Networks I

## Circuit switching technology (cont,..)

### Time Division Switching

- Instead of relatively dumb space division systems, modern digital systems rely on intelligent control of space and time division elements.
- Virtually all modern circuit switches use virtual time division techniques for establishing and maintaining "circuits."
- Time division switching involves the partitioning of a lower-speed bit stream into pieces that share a higher-speed stream with other bit streams.
- The individual pieces, or slots, are manipulated by control logic to route data from input to output.

٣٩

Dr. Ahmed ElShafee, ACU Fall 2011, Networks I

## Circuit switching technology (cont,..)

TDM

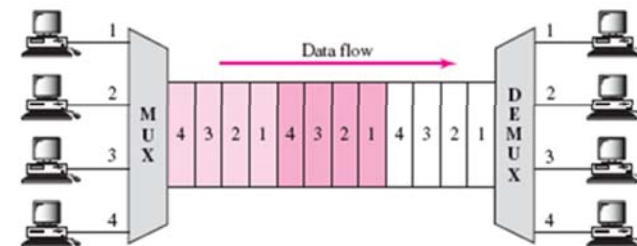

٤٠

Dr. Ahmed ElShafee, ACU Fall 2011, Networks I

## Circuit switching technology (cont,..)

### Soft switches:

A soft switch is a central device in a telecommunications network which connects telephone calls from one phone line to another phone line or terminal PC, typically via the internet, entirely by means of software running on a computer system.

This work was formerly carried out by hardware, with physical switchboards to route the calls.

generally it handles IP-to-IP phone calls,

٤٧

Dr. Ahmed ElShafee, ACU Fall 2011, Networks I

## Circuit switching technology (cont,..)

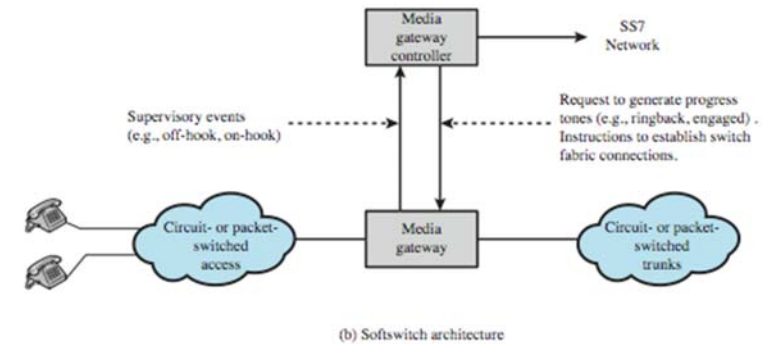

٤٧

Dr. Ahmed ElShafee, ACU Fall 2011, Networks I

## Circuit switching technology (cont,..)

### Soft switch consists of two components:

**Media gateway:** which is the equivalent software version of physical/ virtual connection matrix.

**Media gateway controller:** which is the equivalent software version of switch controller.

٤٧

Dr. Ahmed ElShafee, ACU Fall 2011, Networks I

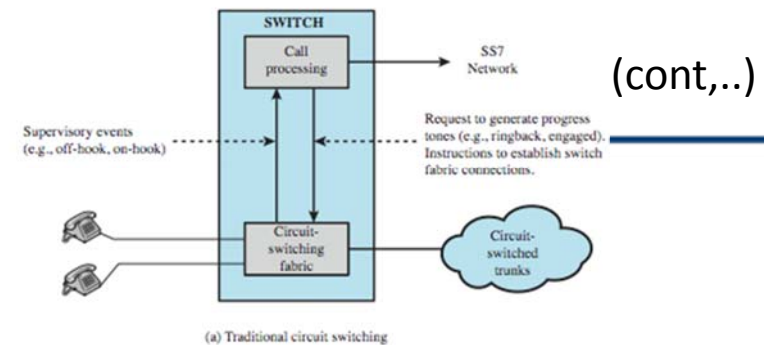

٤٤

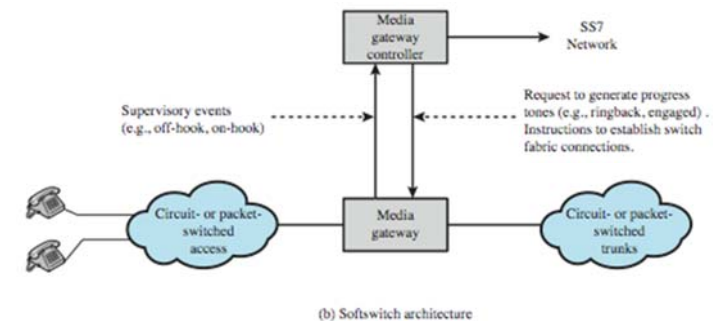

(cont,..)

(b) Softswitch architecture

---

Thanks,...