

Lecture (02)

Data Transmission (II)

Dr. Ahmed ElShafee

1

Dr. Ahmed ElShafee, ACU Spring 2011, Data Communication

Agenda

- Analog and digital signals
- Analog and Digital transmission
- Transmission impairments
- Channel capacity
- Shannon formulas

2

Dr. Ahmed ElShafee, ACU Spring 2011, Data Communication

Introduction

- Have seen already that *analog and digital roughly correspond to continuous and discrete respectively.*
- **data** as entities that convey meaning, or information.
Signals are electric or electromagnetic representations of data.
- **Signaling** is the physical propagation of the signal along a suitable medium.
- **Transmission** is the communication of data by the propagation and processing of signals.

3

Dr. Ahmed ElShafee, ACU Spring 2011, Data Communication

Introduction(cont,..)

- There are two types of signals
 - Analog (acoustic, audio, video)
 - Digital (data)
- And two types of transmissions
 - Analog
 - Digital

4

Dr. Ahmed ElShafee, ACU Spring 2011, Data Communication

Analog and Digital Signals

- Analog data take on continuous values in some interval, the most familiar example being **audio**, which, in the form of acoustic sound waves, can be perceived directly by human beings.

1. Acoustic signals

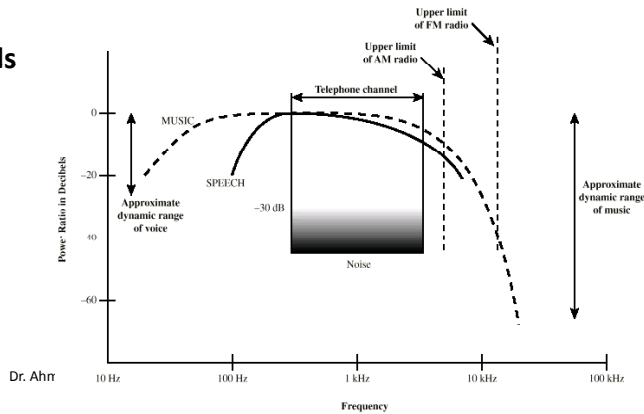

5

Analog and Digital Signals(cont,..)

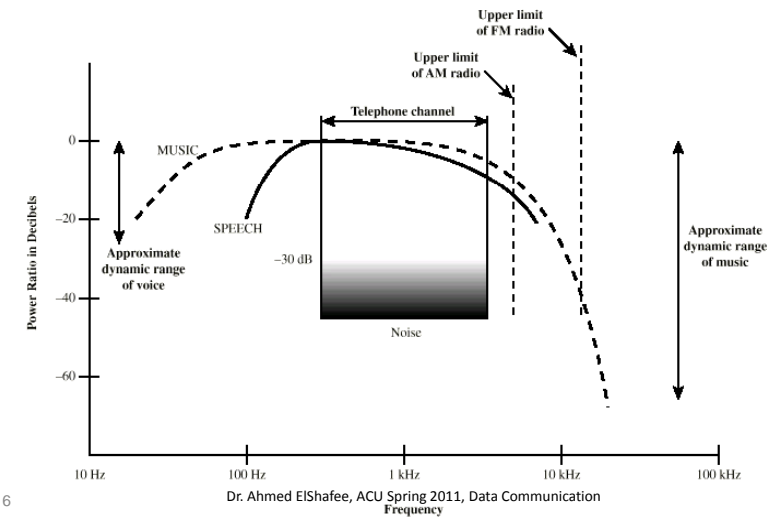

6

Analog and Digital Signals (cont,..)

- Last figure shows the acoustic spectrum for human speech and for music (note log scales).
- Frequency components of typical speech may be found between approximately 100 Hz and 7 kHz, and has a dynamic range of about 25 dB (a shout is approx 300 times louder than whisper).
- Another common example of analog data is **video, as seen on a TV screen.**

7

Analog and Digital Signals (cont,..)

2. Audio signals

- The most familiar example of analog information is **audio/acoustic sound wave** information, eg. human speech.
- It is easily converted to an electrical signal for transmission
- All of the sound frequencies, whose amplitude is measured in terms of loudness, are converted into electrical signal frequencies, whose amplitude is measured in volts



In this graph of a typical analog signal, the variations in amplitude and frequency convey the gradations of loudness and pitch in speech or music. Similar signals are used to transmit television pictures, but at much higher frequencies.

8

Analog and Digital Signals (cont,..)

- The telephone handset contains a simple mechanism for making such a conversion.
- In the case of acoustic data (voice), the data can be represented directly by an electrical signal occupying the same spectrum.
- The spectrum of speech is approximately 100 Hz to 7 kHz, although a much narrower bandwidth will produce acceptable voice reproduction.
- The standard spectrum for a voice channel is 300 to 3400 Hz.

9

Dr. Ahmed ElShafee, ACU Spring 2011, Data Communication

Analog and Digital Signals (cont,..)

3. Video signals

- video signal, produced by a TV camera.
- The US standard is 525 Vertical lines, with 42 lost during vertical retrace
- So the subjective resolution is about 70% of $525-42= 338$ Vertical lines
- Want horizontal and vertical resolutions about the same, and ratio of width to height of a TV screen is 4 : 3, so the horizontal resolution computes to about $4/3 \times 338 = 450$ dots.
- To presents dots as binary data (1s, 0s) (black and white TV), we need $450/2= 225$ bits (will be discussed later).

10

Dr. Ahmed ElShafee, ACU Spring 2011, Data Communication

Analog and Digital Signals (cont,..)

- The frame rate is 30 frames per second to provide motions.
- Thus the horizontal scanning frequency is $(525 \text{ lines}) \times (30 \text{ scan/s}) = 15,750$ lines per second,
- $T=1/f= 63.5 \mu\text{s}/\text{line}$.
- about $11 \mu\text{s}$ are allowed for horizontal retrace, leaving a total of $52.5 \mu\text{s}$ per video line.
- Bit duration will be $(T)=52.5/225=0.233 \text{ usec}/\text{bit}$
- Required band width $(f) = 1/T=4.2 \text{ MHz}$

11

Dr. Ahmed ElShafee, ACU Spring 2011, Data Communication

Analog and Digital Signals (cont,..)

4. Digital Data

- binary data, as generated by terminals, computers, and other data processing equipment and then converted into digital voltage pulses for transmission.

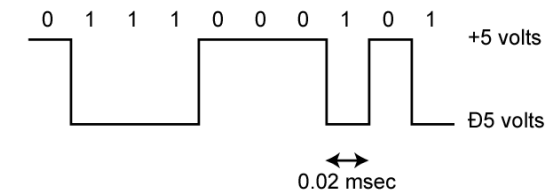

User input at a PC is converted into a stream of binary digits (1s and 0s). In this graph of a typical digital signal, binary one is represented by 5 volts and binary zero is represented by 0 volts. The signal for each bit has a duration of 0.02 msec, giving a data rate of 50,000 bits per second (50 kbps).

Analog and Digital Signals (cont,..)

- A commonly used signal for such data uses two constant (dc) voltage levels, one level for binary 1 and one level for binary 0.
- Consider the bandwidth of such a signal, which depends on the exact shape of the waveform and the sequence of 1s and 0s.
- The greater the bandwidth of the signal, the greater data rate carried by the signal.

13

Dr. Ahmed ElShafee, ACU Spring 2011, Data Communication

Analog and Digital transmission

1. Analog transmission

- is a continuously varying Electric/electromagnetic wave that may be propagated over a variety of medias
- examples are wire media, such as twisted pair and coaxial cable; fiber optic cable; and unguided media, such as atmosphere or space propagation.
- analog signals can be used to transmit both analog data, and digital data using a modem (modulator/demodulator) to modulate the digital data on some carrier frequency.

14

Dr. Ahmed ElShafee, ACU Spring 2011, Data Communication

Analog and Digital transmission (cont,..)

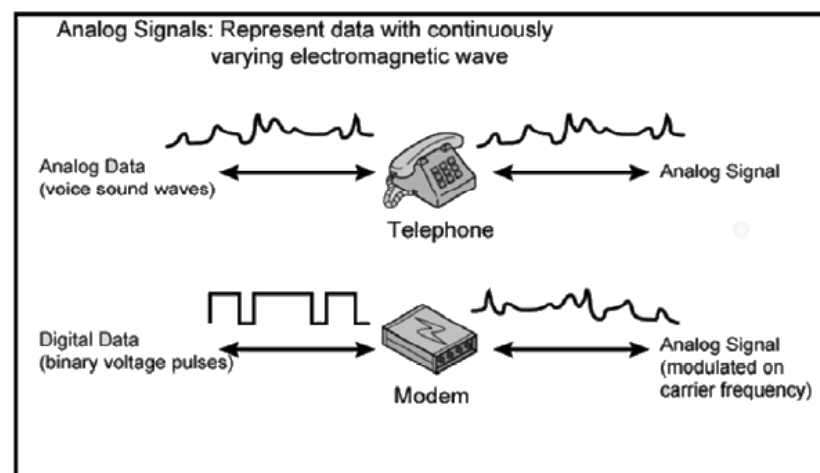

15

Dr. Ahmed ElShafee, ACU Spring 2011, Data Communication

Analog and Digital transmission (cont,..)

- analog signal will become weaker (attenuate) after a certain distance.
- To achieve longer distances, use amplifiers to boost the energy in the signal.
- Unfortunately, the amplifier also boosts the noise components.
- With amplifiers cascaded to achieve long distances, the signal becomes more and more distorted.
- For analog data, such as voice, quite a bit of distortion can be tolerated and the data remain intelligible.
- However, for digital data, cascaded amplifiers will introduce data errors.

16

Dr. Ahmed ElShafee, ACU Spring 2011, Data Communication

Analog and Digital transmission (cont,..)

2. Digital transmission

- is a sequence of voltage pulses that may be transmitted over a suitable medium.
- a constant positive voltage level may represent binary 0 and a constant negative voltage level may represent binary 1.
- digital signals can be used to transmit both analog signals and digital data.
- Analog signals can be converted to digital using a (Analog to digital converters) codec (coder-decoder), which takes an analog signal that directly represents the voice data and approximates that signal by a bit stream.

17

Dr. Ahmed ElShafee, ACU Spring 2011, Data Communication

Analog and Digital transmission (cont,..)

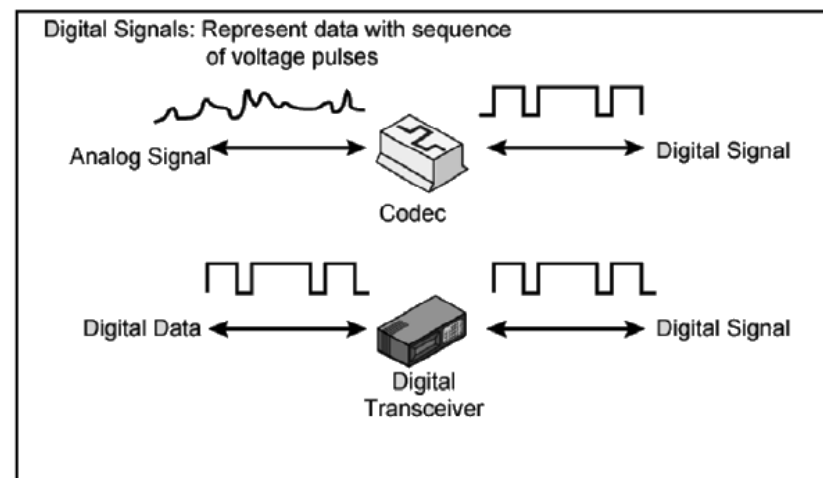

18

Dr. Ahmed ElShafee, ACU Spring 2011, Data Communication

Analog and Digital transmission (cont,..)

- At the receiving end, the bit stream is used to reconstruct the analog data.
- Digital data can be directly represented by digital signals.
- A digital signal can be transmitted only a limited distance before attenuation, noise
- To achieve greater distances, repeaters are used.
- A repeater receives the digital signal, recovers the pattern of 1s and 0s, and retransmits a new signal.
- Thus the attenuation is overcome.

19

Dr. Ahmed ElShafee, ACU Spring 2011, Data Communication

Analog and Digital transmission (cont,..)

Advantages of digital transmission

- cheaper than analog signaling
- less susceptible to noise interference

disadvantages of digital transmission

- suffer more from attenuation than do analog signals
- Takes higher band width than analog signal

20

Dr. Ahmed ElShafee, ACU Spring 2011, Data Communication

Analog and Digital transmission (cont,..)

Figure shows a sequence of voltage pulses, Because of the attenuation, the pulses become rounded and smaller.

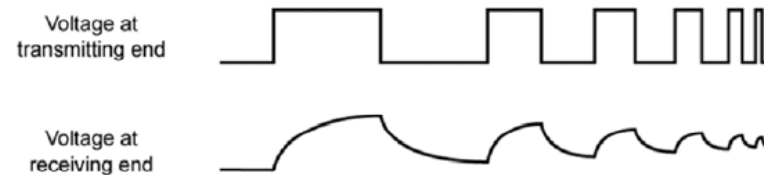

21

Dr. Ahmed ElShafee, ACU Spring 2011, Data Communication

Analog and Digital transmission (cont,..)

Summary

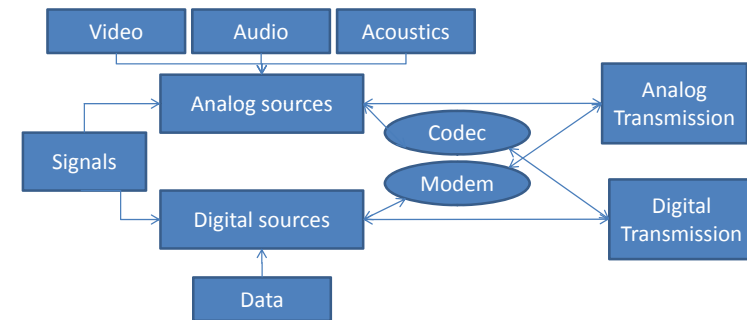

22

Dr. Ahmed ElShafee, ACU Spring 2011, Data Communication

Transmission impairments

- With any communications system, the signal that is received may differ from the signal that is transmitted due to various transmission impairments
- For analog signals, these impairments can degrade the signal quality.
- For digital signals, bit errors may be introduced, such that a binary 1 is transformed into a binary 0 or vice versa.

23

Dr. Ahmed ElShafee, ACU Spring 2011, Data Communication

Transmission impairments (con,..)

1. Attenuation

- Attenuation is where the strength of a signal falls off with distance over any transmission medium.
- For guided media, this is generally exponential and thus is typically expressed as a constant number of decibels per unit distance.
- For unguided media, attenuation is a more complex function of distance and the makeup of the atmosphere.

24

Dr. Ahmed ElShafee, ACU Spring 2011, Data Communication

Transmission impairments (con,..)

- Attenuation introduces three considerations for the transmission engineer
 1. First, a received signal must have sufficient strength so that the electronic circuitry in the receiver can detect the signal.
 2. Second, the signal must maintain a level sufficiently higher than noise to be received without error.
these can be solved using amplifiers and repeaters,...
 3. Third, attenuation varies with frequency.
Solved by using equalizing attenuation across a band of frequencies

25

Dr. Ahmed ElShafee, ACU Spring 2011, Data Communication

Transmission impairments (con,..)

Examples (how to *equalize attenuation across a band of frequencies*);

- Voice-grade telephone lines by using loading coils that change the electrical properties of the line; the result is to smooth out attenuation effects.
- Another example is to use amplifiers that amplify high frequencies more than lower frequencies.

26

Dr. Ahmed ElShafee, ACU Spring 2011, Data Communication

Transmission impairments (con,..)

2. Delay distortion

- velocity of propagation of a signal through a guided medium varies with frequency.
- For a band limited signal, the velocity tends to be highest near the center frequency and fall off toward the two edges of the band.
- Thus various frequency components of a signal will arrive at the receiver at different times, resulting in phase shifts between the different frequencies.

27

Dr. Ahmed ElShafee, ACU Spring 2011, Data Communication

Transmission impairments (con,..)

- Delay distortion is a critical for digital data, because some components of one bit position will spill over into other bit positions, causing **inter-symbol interference**.
- This is a major limitation to maximum bit rate over a transmission channel.

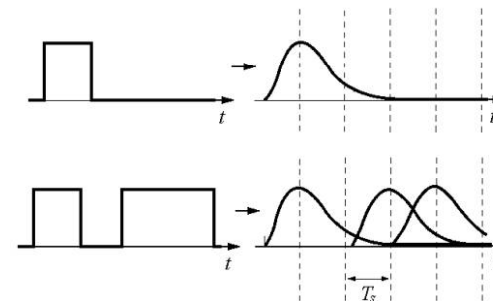

28

Transmission impairments (con,..)

3. Noise

- For any data transmission event, the received signal will consist of the transmitted signal, modified by the various distortions imposed by the transmission system, plus additional unwanted signals, referred to as noise
- Noise is inserted somewhere between transmission and reception.
- Noise is a major limiting factor in communications system performance.
- Noise may be divided into four categories;

29

Dr. Ahmed ElShafee, ACU Spring 2011, Data Communication

Transmission impairments (con,..)

3.1 Thermal noise

- due to thermal agitation of electrons.
- It is present in all electronic devices and transmission media and is a function of temperature.
- Thermal noise is uniformly distributed across the bandwidths typically used in communications systems and hence is often referred to as **white noise**.

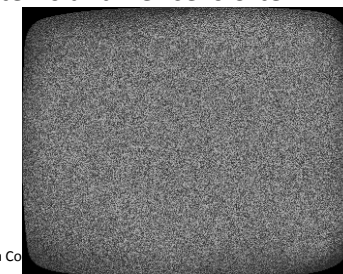

30

Dr. Ahmed ElShafee, ACU Spring 2011, Data Co

Transmission impairments (con,..)

3.2 inter-modulation noise

- The effect of inter-modulation noise is to produce signals at a frequency that is the sum or difference of the two original frequencies or multiples of those frequencies, thus possibly interfering with services at these frequencies.
- It is produced by nonlinearities in the transmitter, receiver, and/or intervening transmission medium.

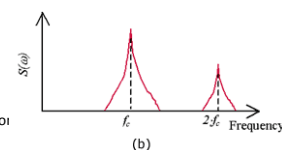
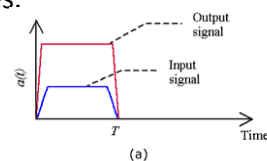

$$\sin s \cos f = \frac{\sin (s+f) + \sin (s-f)}{2}$$
$$\cos s \cos f = \frac{\cos (s+f) + \cos (s-f)}{2}$$
$$\sin s \sin f = \frac{\cos (s-f) - \cos (s+f)}{2}$$

Dr. Ahmed ElShafee, ACU Spring 2011, Data Communication

Transmission impairments (con,..)

3.3 Crosstalk

- is an unwanted coupling between signal paths.
- It can occur by electrical coupling between nearby twisted pairs or, rarely, coax cable lines carrying multiple signals.
- It can also occur when microwave antennas pick up unwanted signals;

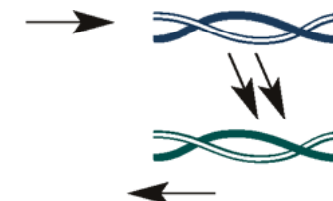

32

Dr. Ahmed ElShafee, ACU Spring 2011, Data Communication

Transmission impairments (con,..)

3.4 Impulse noise

- is non-continuous, consisting of irregular pulses or noise spikes of short duration and of relatively high amplitude.
- It is generated from a variety of causes, including external electromagnetic disturbances, such as lightning, and faults and flaws in the communications system.
- It is generally only a minor annoyance for analog data.
- However impulse noise is the primary source of error in digital data communication.
- For example, a sharp spike of energy of 0.01 s duration would not destroy any voice data but would wash out about 560 bits of data being transmitted at 56 kbps.

33

Dr. Ahmed ElShafee, ACU Spring 2011, Data Communication

Channel Capacity

Data rate,

in bits per second (bps), at which data can be communicated

Bandwidth,

as constrained by the transmitter and the nature of the transmission medium, expressed in cycles per second, or Hertz

Noise,

average level of noise over the communications path

Error rate,

at which errors occur, where an error is the reception of a 1 when a 0 was transmitted or the reception of a 0 when a 1 was transmitted

34

Dr. Ahmed ElShafee, ACU Spring 2011, Data Communication

Channel Capacity (cont,..)

All transmission channels of any practical interest are of limited bandwidth, due to

1. physical properties of the transmission medium
 2. to prevent interference from other sources.
- So you want to make as efficient use as possible of a given bandwidth.
 - This means that we would like to get as high a data rate as possible at a particular limit of error rate for a given bandwidth.
 - The main constraint on achieving this efficiency is noise.

35

Dr. Ahmed ElShafee, ACU Spring 2011, Data Communication

Channel Capacity (cont,..)

Nyquist bandwidth

- Consider a noise free channel where the limitation on data rate is simply the bandwidth of the signal.
- Nyquist states that if signal bandwidth (frequency) in B Hz, it can carry data up to $2B$ bps

36

Dr. Ahmed ElShafee, ACU Spring 2011, Data Communication

Channel Capacity (cont,..)

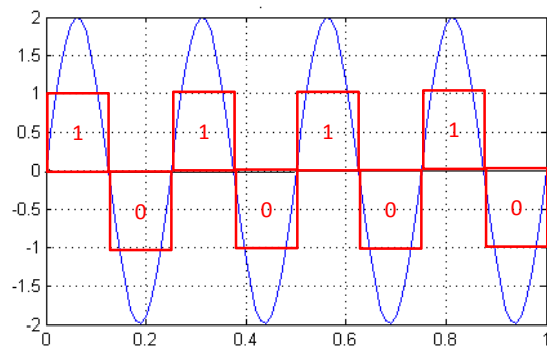

37

Dr. Ahmed ElShafee, ACU Spring 2011, Data Communication

Channel Capacity (cont,..)

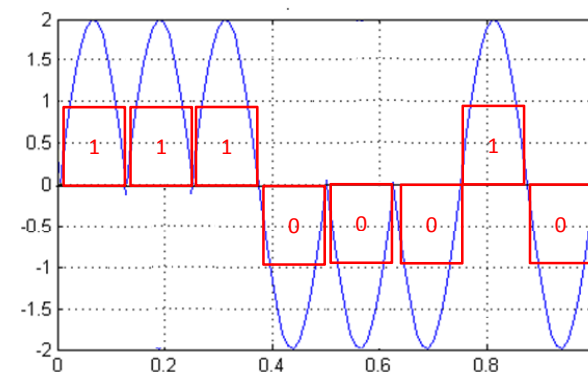

38

Dr. Ahmed ElShafee, ACU Spring 2011, Data Communication

Channel Capacity (cont,..)

General Nyquist bandwidth

- With multilevel signaling, the Nyquist formulation becomes:

$$C = 2B \log_2 M,$$

where M is the number of discrete signal or voltage levels.

C is the channel capacity bps

B is the channel band width

- Ex1: using binary symbols 0s, 1s, then number of levels (M)=2 then $C=2 \times B \times \log_2 2=2B$ bps
- Ex2, if four possible voltage levels are used as signals, then each signal element can represent two bits, so number of levels (M)=4, then $C=2 \times B \times \log_2 4= 4B$ bps

39

Dr. Ahmed ElShafee, ACU Spring 2011, Data Communication

Channel Capacity (cont,..)

- So, for a given bandwidth, the data rate can be increased by increasing the number of different signal elements.
- However, this places an increased burden on the receiver, as it must distinguish one of M possible signal elements.
- *Noise and* other impairments on the transmission line will limit the practical value of M .

40

Dr. Ahmed ElShafee, ACU Spring 2011, Data Communication

Shannon formulas

- Consider the relationship among data rate, noise, and error rate.
- The presence of noise can corrupt one or more bits.
- If the data rate is increased, then the bits become "shorter" so that more bits are affected by a given pattern of noise.
- Mathematician Claude Shannon developed a formula relating these.
- For a given level of noise, expect that a greater signal strength would improve the ability to receive data correctly in the presence of noise.
- The key parameter involved is the **signal-to-noise ratio (SNR, or S/N)**,

41

Dr. Ahmed ElShafee, ACU Spring 2011, Data Communication

Shannon formulas (cont,..)

- SNR; is the ratio of the power in a signal to the power contained in the noise that is present at a particular point in the transmission.
- Typically, this ratio is measured at a receiver, because it is at this point that an attempt is made to process the signal and recover the data.
- Measured in decibels,

$$\text{SNR}_{\text{db}} = 10 \log_{10}(\text{signal/noise})$$

42

Dr. Ahmed ElShafee, ACU Spring 2011, Data Communication

Shannon formulas (cont,..)

- Then he developed the relation between SNR and channel capacity

$$\text{Capacity } C = B \log_2(1 + \text{SNR})$$

- In practice, however, only much lower rates are achieved, in part because formula only assumes white noise (thermal noise).

43

Dr. Ahmed ElShafee, ACU Spring 2011, Data Communication

Thanks,...

44

Dr. Ahmed ElShafee, ACU Spring 2011, Data Communication